

## LE3 - JETRONIC SYSTEM

### INTRODUCTION

The electronic injection system LE3 - JETRONIC is an inductive discharge transistorized system CU equipped.

Ignition is ensured by an electronic ignition system with its own control unit.

Necessary units to operate various controls are collected by proper sensors which transform them into electrical signals.

These are:

- battery voltage
- accelerator throttle position signal (wholly closed or open)
- intake air temperature
- engine cooling fluid temperature
- air quantity intake from engine
- oxygen quantity in exhaust gas
- idle rpm (from distributor)

The electronic control unit (CU) collects data and calculates injectors opening time as a function of instantaneous idle and engine load conditions.

Once the calculation has been car-

ried out, CU provides to open injectors at foreseen time.

Since difference between fuel pressure and air pressure in manifold is kept constant by a gauge, injected fuel quantity will be proportioned to supply time.

Furthermore, the injection CU is able to activate each time those actions considered most suitable with relation to particular engine situations (e.g. injector for cold start, fuel feed interruption during release phase).

The CU also controls the supply of fuel pump.

WIRING DIAGRAM OF INJECTION AND IGNITION SYSTEM

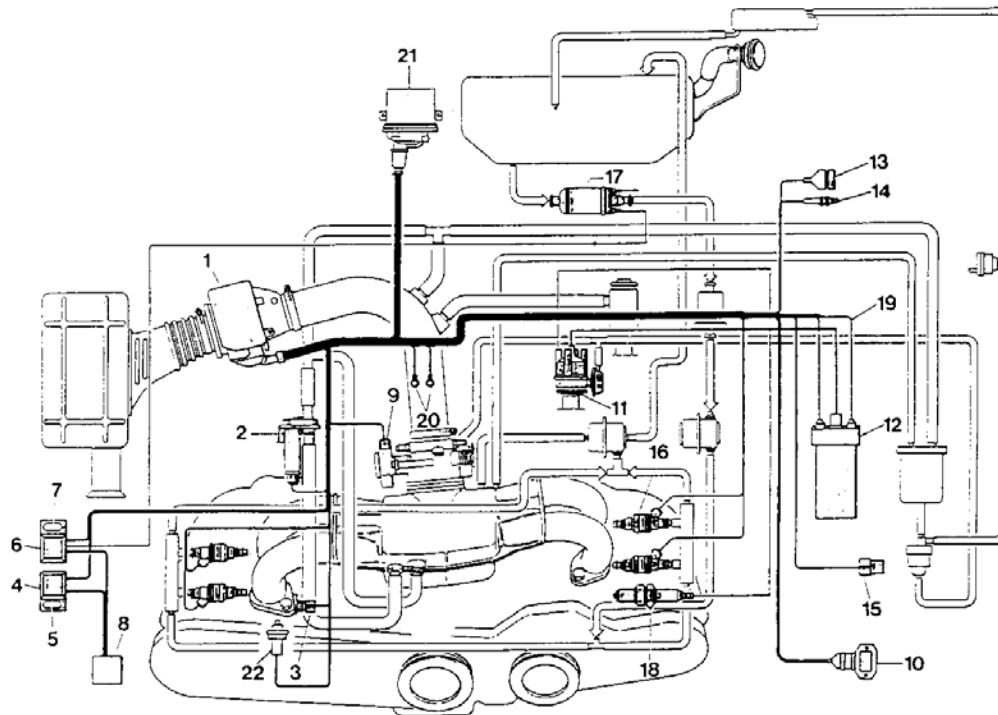

- 1 Air flow sensor/injection
- 2 Extra air solenoid valve
- 3 Engine cooling liquid temperature sensor
- 4 Main injection solenoid starter
- 5 Lambda probe resistance fuse (7,5 A)
- 6 Fuel pump solenoid starter
- 7 Fuel pump fuse (15 A)
- 8 Vehicle wiring connection
- 9 Min. & Max. throttle opening switch
- 10 Power module
- 11 Ignition distributor

- 12 Ignition coil
- 13 Lambda probe resistance connector
- 14 Lambda probe signal connector
- 15 Lambda probe connector
- 16 Injectors
- 17 Fuel pump
- 18 Spark plugs
- 19 Cable to detect engine rpm
- 20 Centralized grounds
- 21 Ignition CU
- 22 Coolant temperature thermal contact

## **INJECTION AND IGNITION SYSTEMS DIAGNOSIS AND CORRECTIVE ACTIONS**

**WARNING:**

**SHOULD ONE OF THE DIAGNOSIS TESTS LISTED HEREBELOW RESULT NOT POSITIVE, LOCATE THE CAUSE OF THE FAULTY CONDITION BY CARRYING OUT THE TROUBLESHOOTING PROCEDURE.**

**ENGINE FAILS TO START**

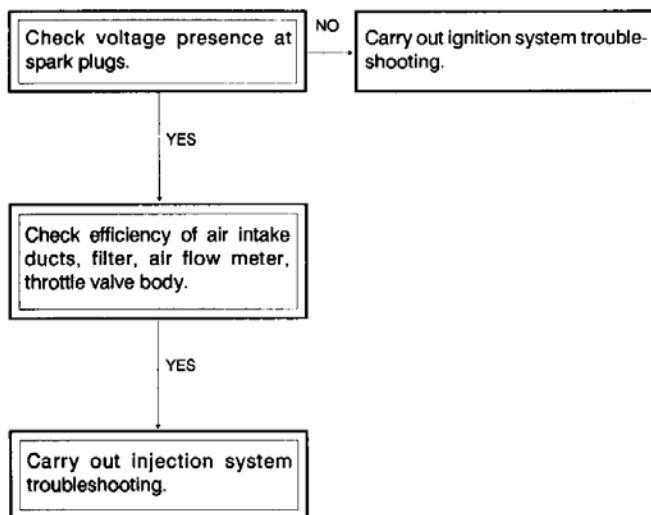

**ENGINE HAS DIFFICULTY IN STARTING**

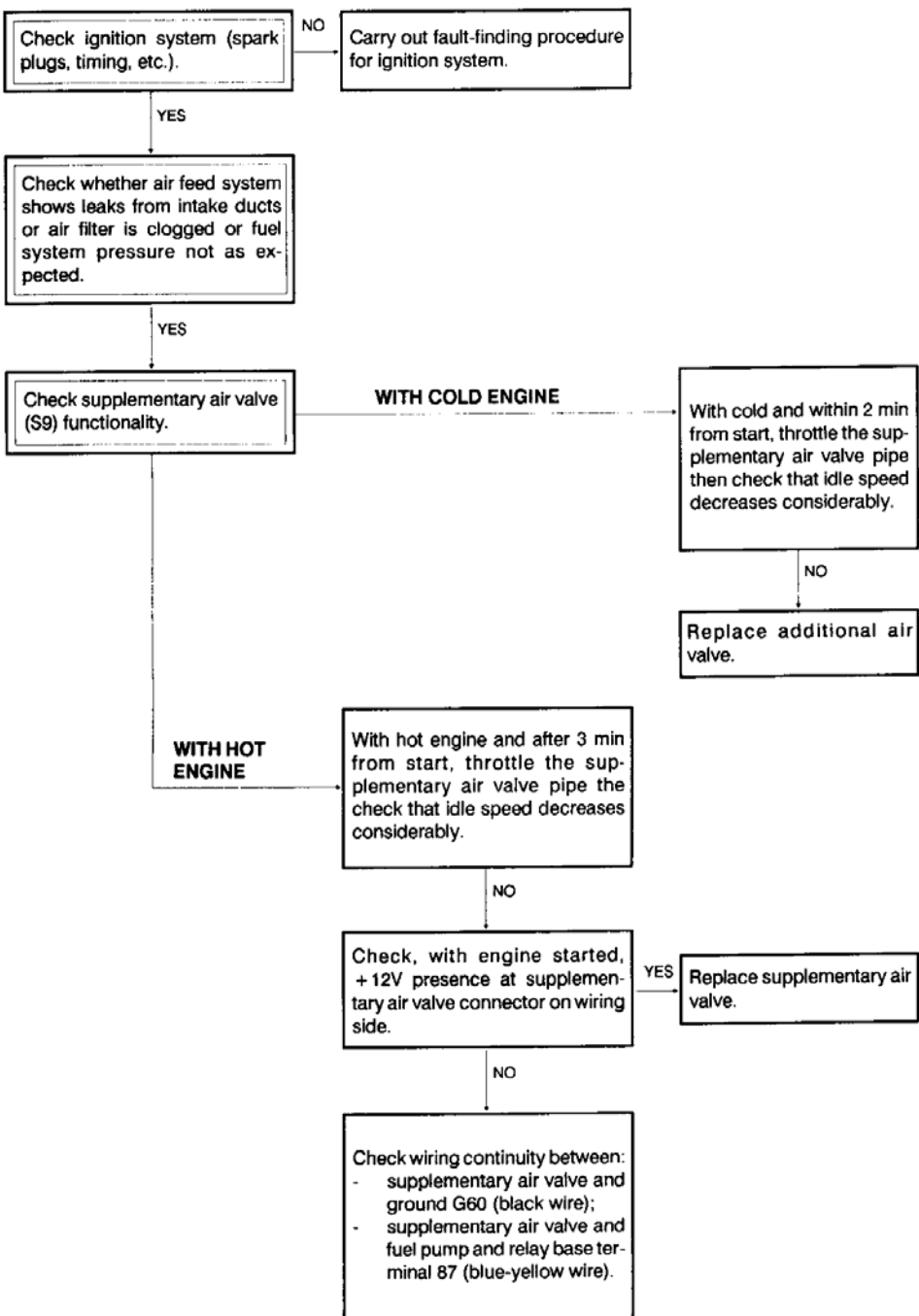

**IDLE SPEED NOT REGULAR**

Check throttle valve body flux is correct.  
Check whether there are leaks from air intake ducts and air filter is clogged.

YES

Carry out ignition and injection systems troubleshooting.

**IRREGULARITIES ON SPEEDING UP AND BURSTS AT RELEASE**

Check whether fuel system pressure is correct and ignition system (spark plugs, timing, etc.) operates correctly.

NO

Carry out ignition system troubleshooting as well as Test N. 1 of injection system troubleshooting.

YES

Check whether there are leaks from air intake ducts.

YES

Check grounds G60 efficiency.

YES

Check efficiency of throttle valve min. and max. opening switch as stated in the injection system troubleshooting Procedure N. 4.

**TOO MUCH FUEL CONSUMPTION**

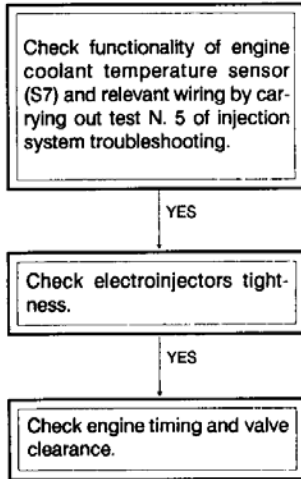

**EXHAUST EMISSIONS NOT CORRECT  
(SPECIFIC TEST FOR VERSIONS FITTED WITH LAMBDA PROBE)**

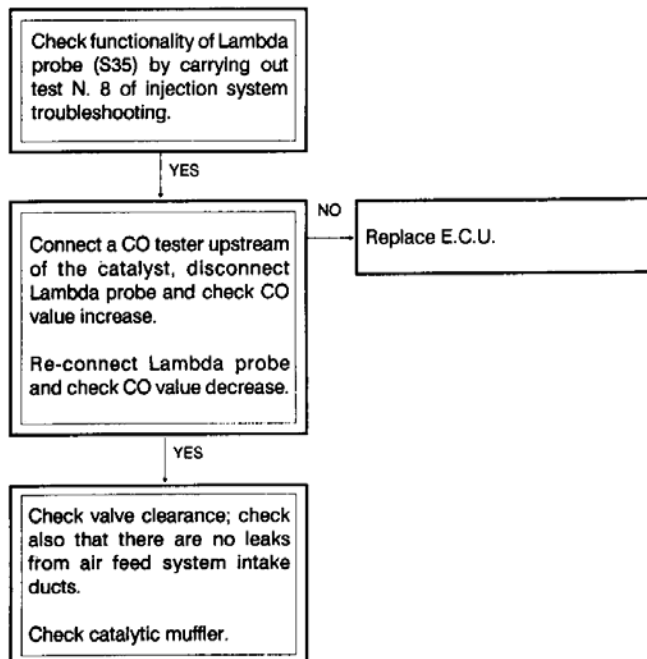

## **INJECTION SYSTEM TROUBLESHOOTING**

**NOTE:**

**THIS TROUBLESHOOTING WILL BE MAINLY DEALING WITH THE SYSTEM'S ELECTRIC/ELECTRONIC DIAGNOSIS ALONG WITH THE SENSORS AND ACTUATORS CONNECTED TO IT.**

**SHOULD A FAULTY CONDITION PERSIST AT THE END OF THE TESTS, IT WILL BE NECESSARY TO CHECK THE MAIN MECHANICAL UNITS SUCH AS VALVES, CYLINDERS, COUPLINGS, SEALS, INTAKE DUCTS, AND SO ON.**



LE3 - JETRONIC SYSTEM

TEST No. 1 - CHECK OF FUEL PUMP CONTROL

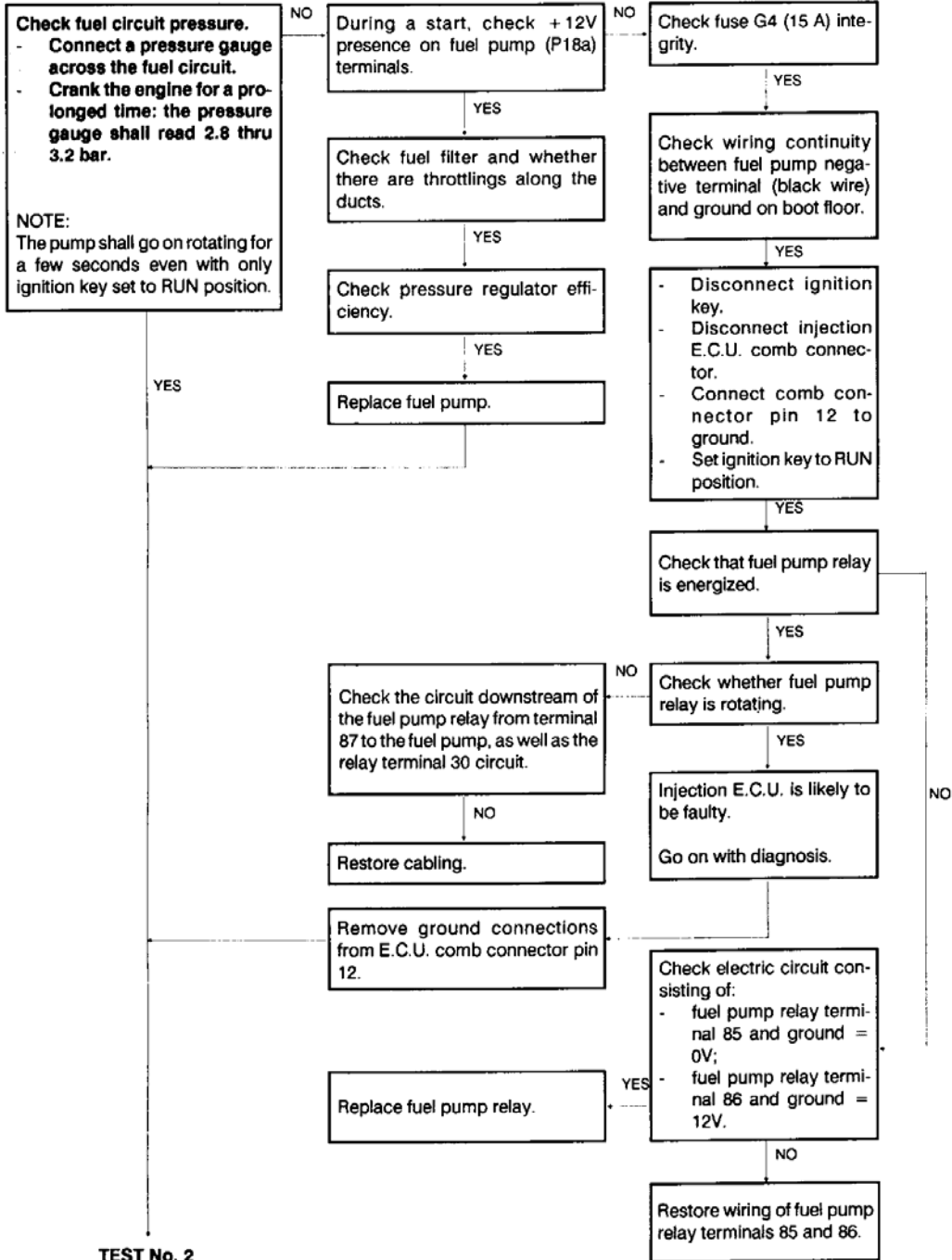

**TEST No. 2 - GROUND CHECK (E.C.U. PINS 4 AND 5)**

Set multimeter to 200 Ohm f.s.  
Ignition key must be OFF.  
Disconnect injection E.C.U.  
comb connector.

**Check continuity between:**  
- E.C.U. S1 comb connector  
pin 4 and ground G60;  
- E.C.U. S1 comb connector  
pin 5 and ground G60.

NO

Restore wiring between:  
- E.C.U. S1 comb connector  
pin 4 and ground G60;  
- E.C.U. S1 comb connector  
pin 5 and ground G60.  
Check also grounds G60 func-  
tionality.

YES

**TEST No. 3**

LE3 - JETRONIC SYSTEM

**TEST No. 3 - CHECK OF CONNECTION TO R.P.M. SIGNAL (E.C.U. PIN 1)**

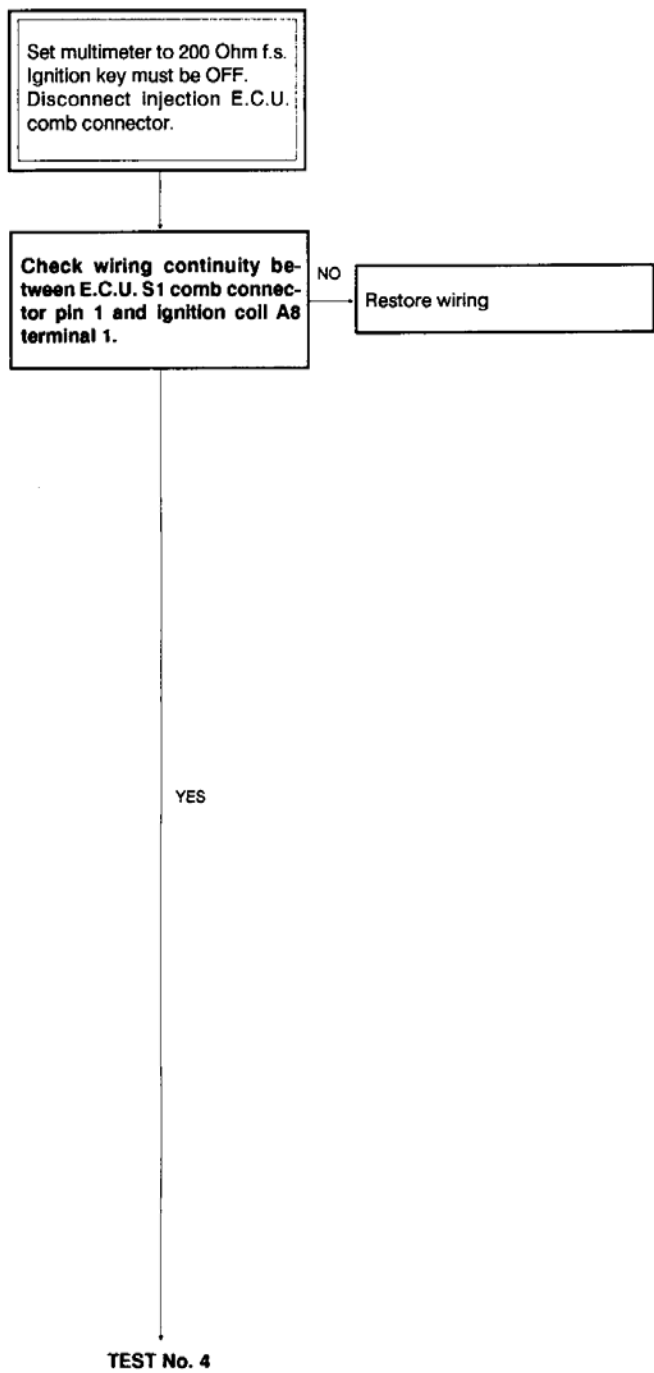

LE3 - JETRONIC SYSTEM

**TEST No. 4 - CHECK OF THROTTLE VALVE MIN. AND MAX. OPENING SWITCH (E.C.U. PINS 15 AND 14)**

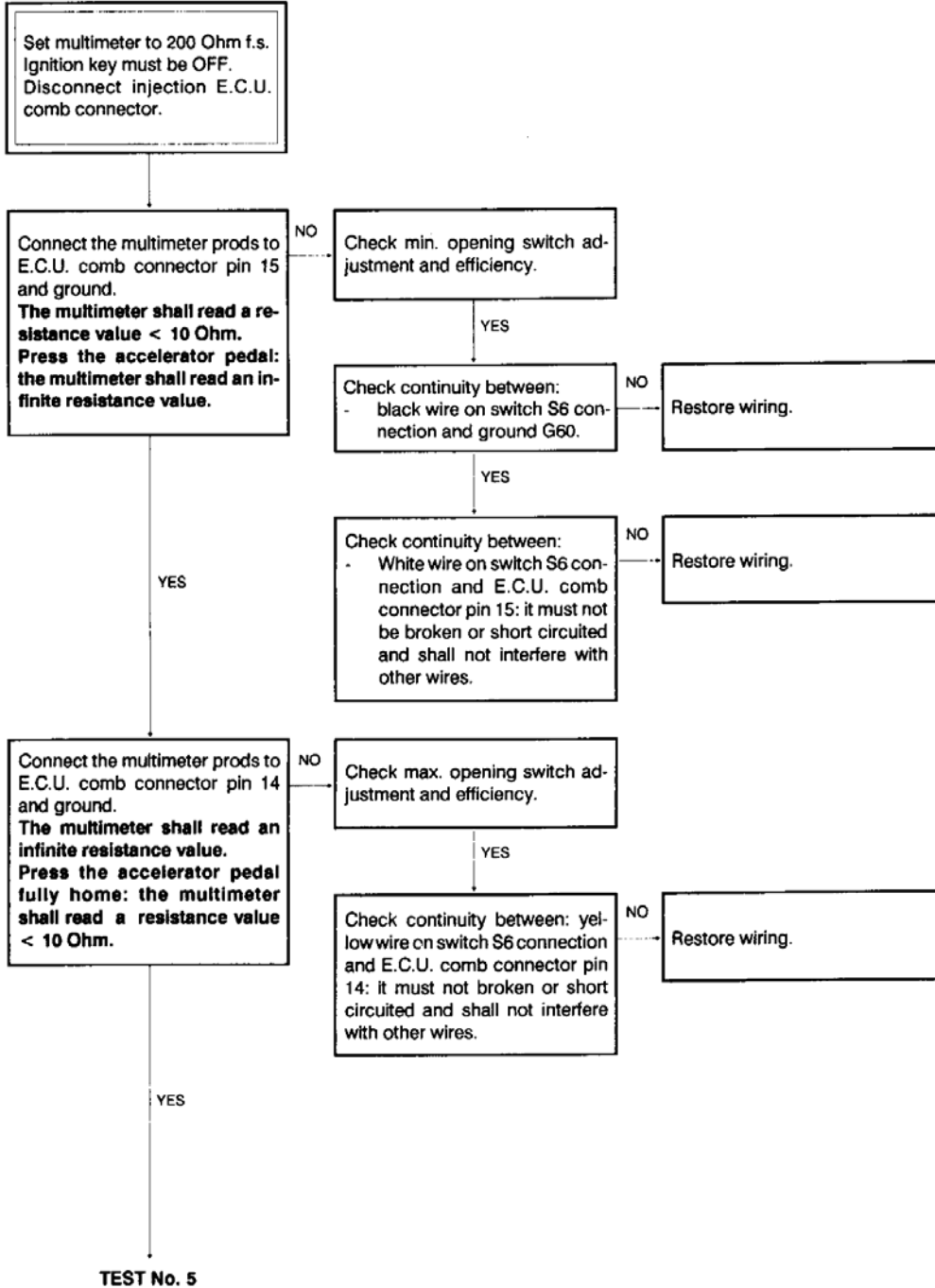

**TEST No. 5 - CHECK OF ENGINE COOLANT TEMPERATURE SENSOR (E.C.U. PIN 8)**

Set multimeter to 20kOhm f.s.  
Have ignition key OFF.  
Disconnect Injection E.C.U.

Check a resistance value between E.C.U. comb connector pin 8 and ground, varying according to engine coolant temperature, as per the following curve.

| Tc (°C) | R (Ohms) |
|---------|----------|
| 10      | 70000    |
| 20      | 50000    |
| 30      | 35000    |
| 40      | 25000    |
| 50      | 18000    |
| 60      | 13000    |
| 70      | 10000    |
| 80      | 7500     |
| 90      | 5500     |
| 100     | 4000     |
| 110     | 3000     |
| 120     | 2200     |
| 130     | 1500     |

Check wiring continuity between:

- E.C.U. S1 comb connector pin 8 and brown wire on temperature sensor S7 connection;
- ground G60 and black wire on sensor S7 connection.

Restore wiring.

Replace engine coolant temperature sensor S7.

TEST No. 6

TEST No. 6 - CHECK OF ELECTROINJECTORS CIRCUIT

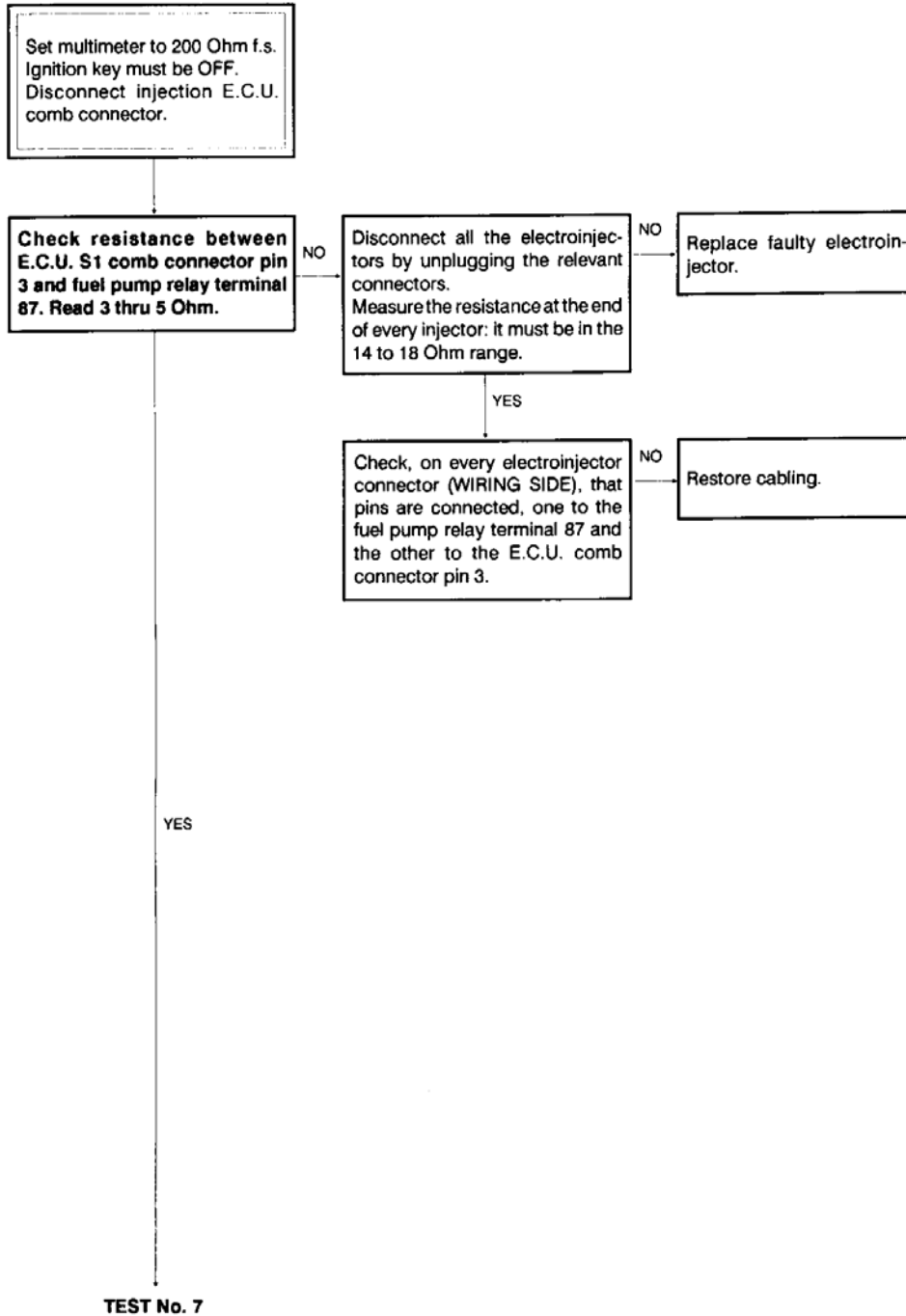

**TEST No. 7 - CHECK OF E.C.U. PINS 2 AND 7 + 12V**

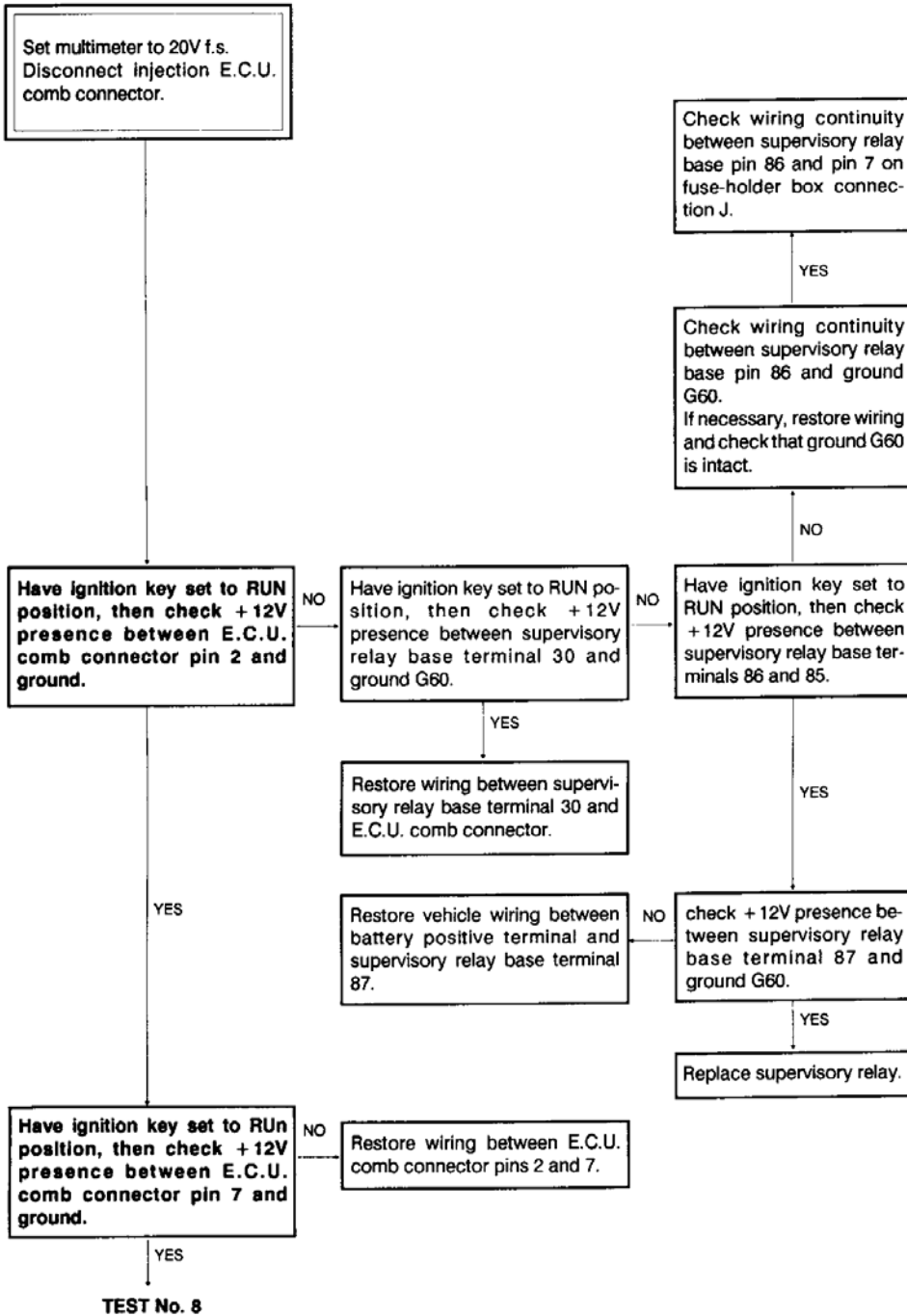

**TEST No. 8 - CHECK OF LAMBDA PROBE (E.C.U. PIN 13)**  
**(SPECIFIC TEST FOR VERSIONS FITTED WITH LAMBDA PROBE)**

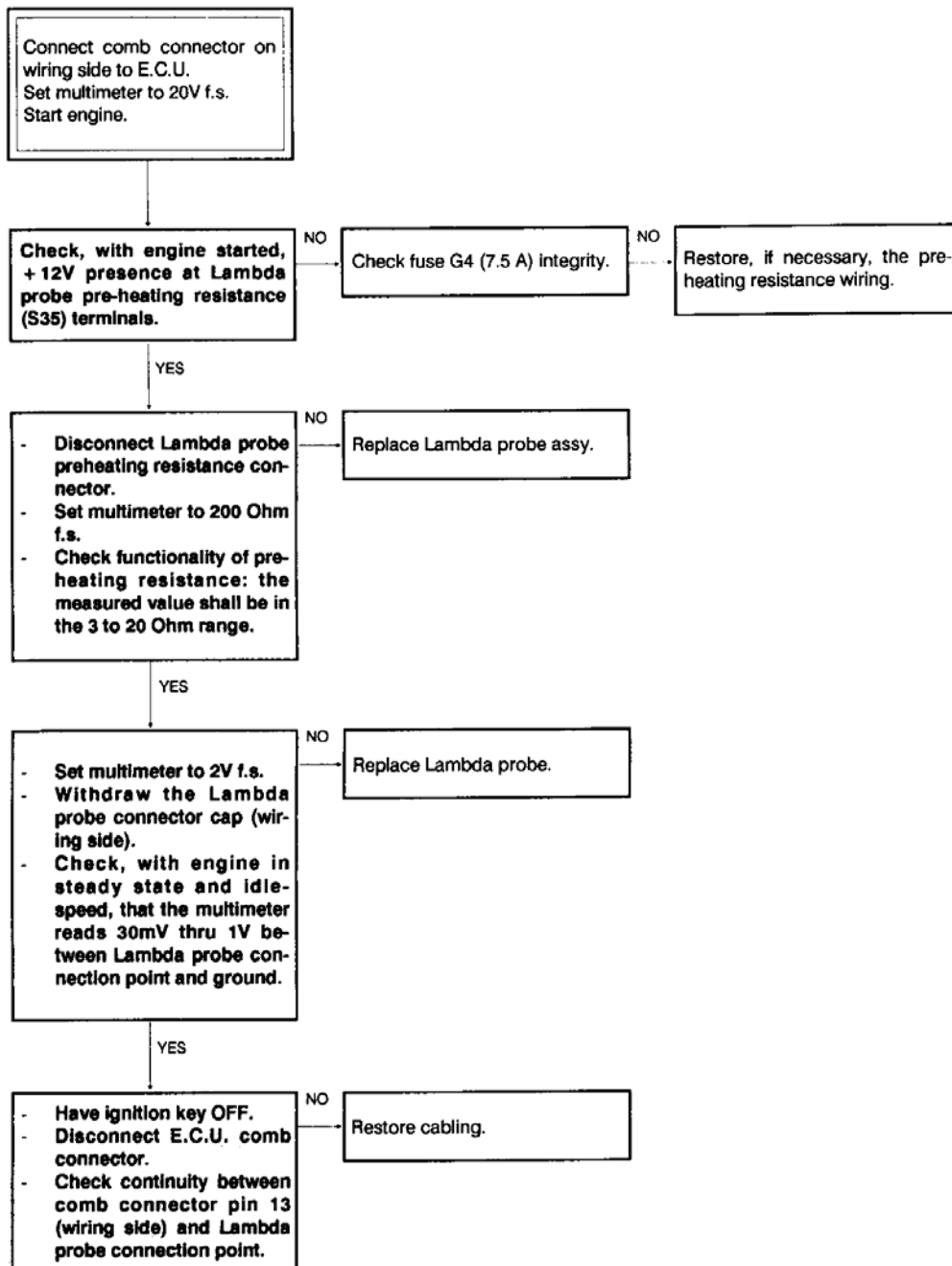



## **INJECTION SYSTEM TROUBLESHOOTING**

**NOTE:**

**THIS TROUBLESHOOTING WILL BE MAINLY DEALING WITH THE SYSTEM'S ELECTRIC/ELECTRONIC DIAGNOSIS ALONG WITH THE SENSORS AND ACTUATORS CONNECTED TO IT.**

**SHOULD A FAULTY CONDITION PERSIST AT THE END OF THE TESTS, IT WILL BE NECESSARY TO CHECK THE MAIN MECHANICAL UNITS SUCH AS VALVES, CYLINDERS, COUPLINGS, SEALS, INTAKE DUCTS, AND SO ON.**

LE3 - JETRONIC SYSTEM

ENGINE FAILS TO START

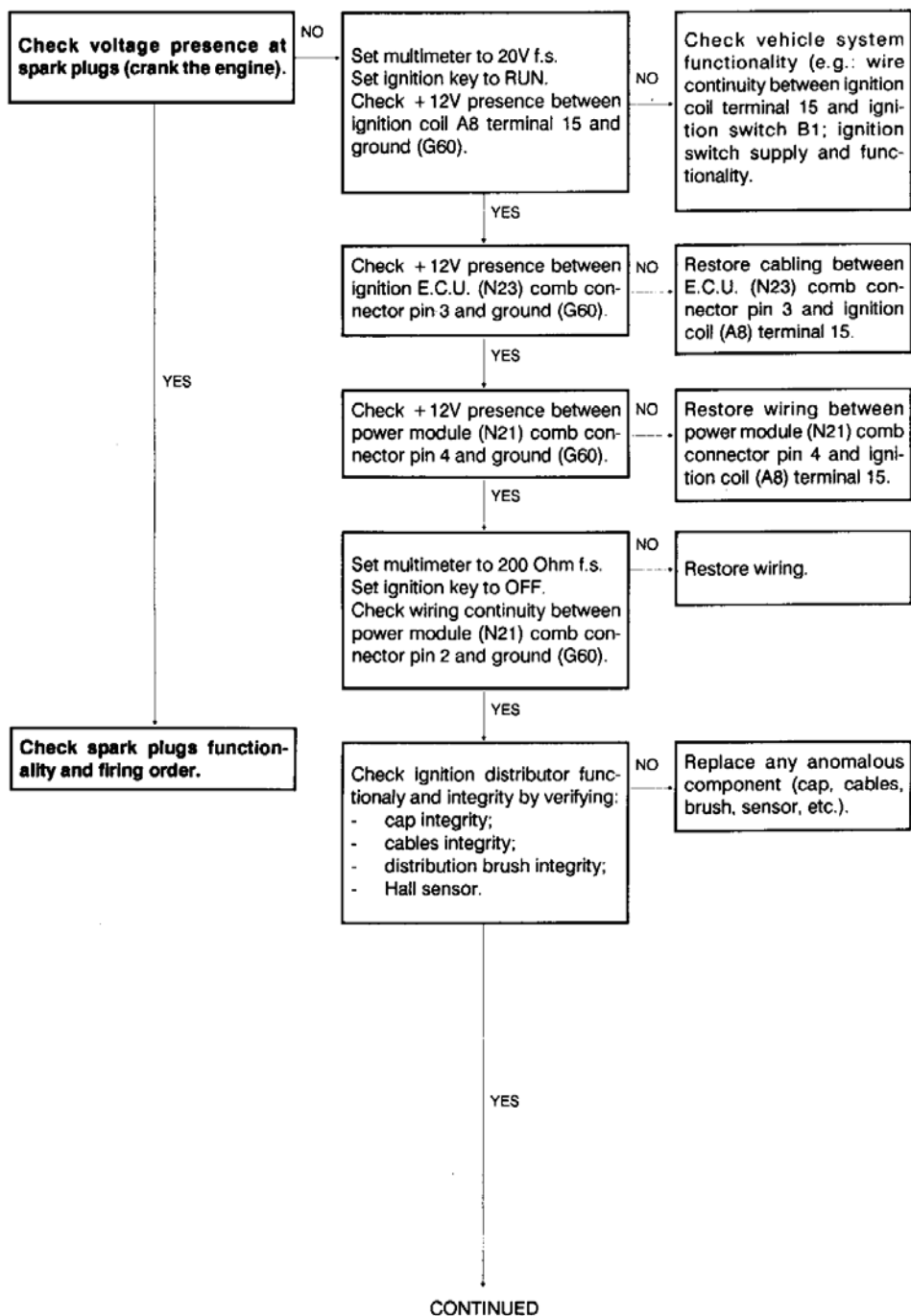

LE3 - JETRONIC SYSTEM

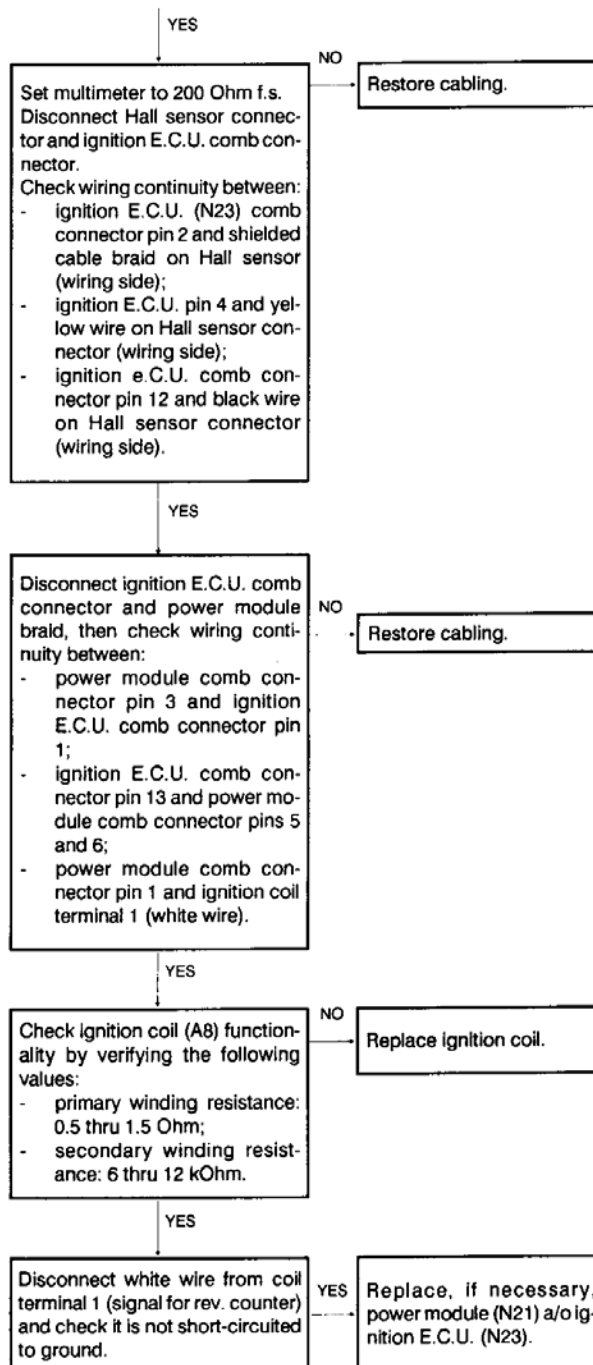

**CHECK OF SPARK ADVANCE VARIATION**

**TEST No. 1**

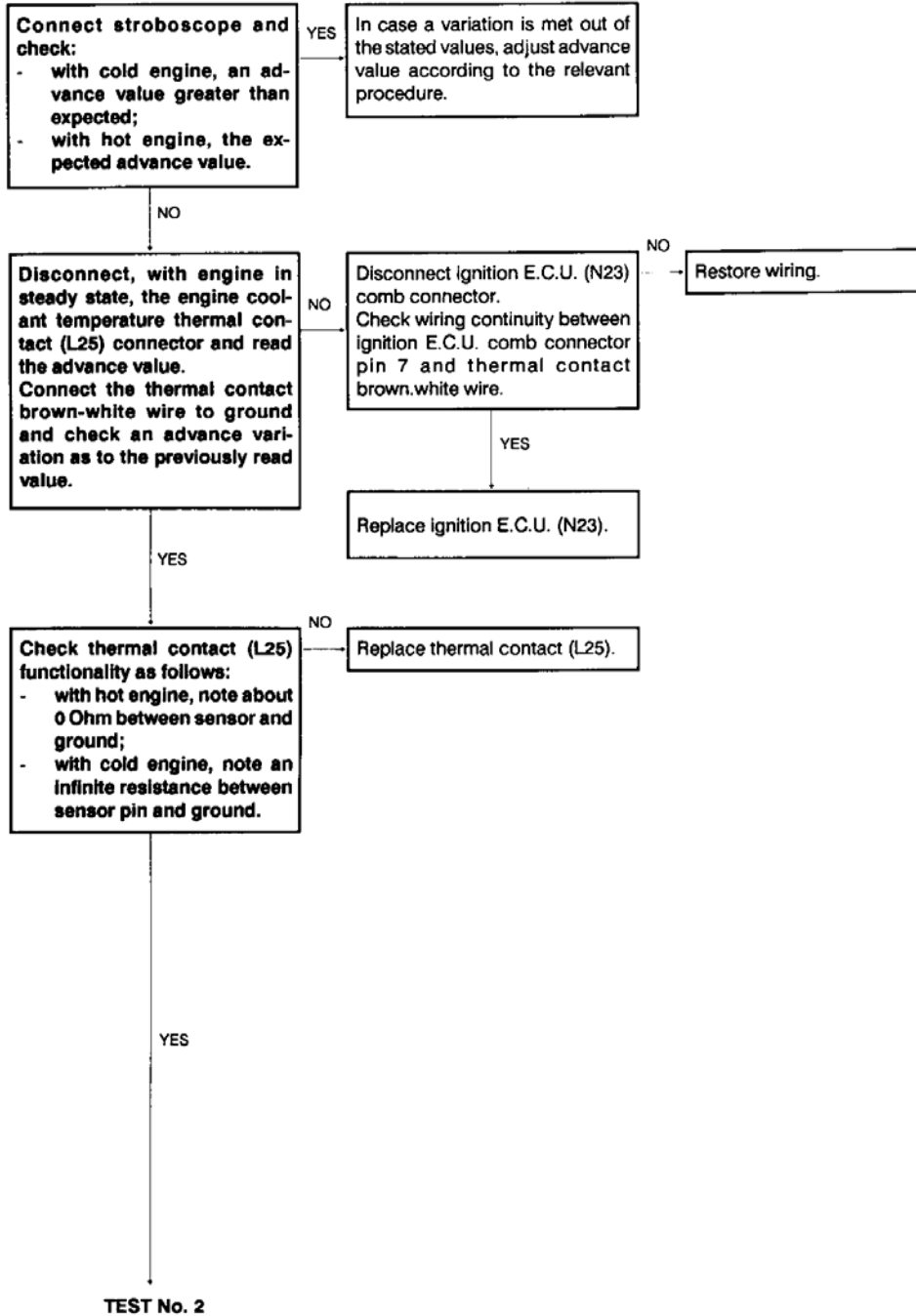

TEST No. 2

